

DWM-314-G

5G Multi-Connect Modem



Key Features



5G SA & NSA



Multi-Port GE Connectivity



Dual-SIM Failover



VPN Security



Industrial Grade Design



Management Platform

Applications

- Parking Lot
- Small Shop
- Surveillance
- Self-Service

The D-Link DWM-314-G 5G Multi-Connect Modem provides 5G-NR and 4G-LTE dual-mode connectivity. It also features four gigabit Ethernet ports for connectivity extension to meet M2M application requirements.

Unleash 5G Power for Superior M2M Connectivity

The DWM-314-G 5G Multi-Connect Modem harnesses 5G technology to accelerate ultra-fast speed, reduce latency, and ensure reliable connectivity with its automatic failover feature, enhancing machine-to-machine communication. Ideal for smart parking poles, kiosks and ATMs, this modem supports real-time data transfer and remote management. Built-in 4-port Gigabit Ethernet simplify setup and reduce the extra power supply wires and the need for additional switch, making it perfect for space-constrained environments and cost saving. Additionally, secure VPN capabilities safeguard data transmission, ensuring robust security for all connected devices.

Plug and Play for Easy Installation

Designed for instant setup, the DWM-314-G 5G modem offers real-time remote access and uninterrupted connectivity over long distances. Equipped with dual SIM slots and simply insert two Micro-SIM cards (3FF) for a reliable connection to the high-speed 5G network with seamless 4G/5G switching and for failover redundancy, even if one carrier network is down. Convenient wall and DIN-rail mounting options allow the DWM-314-G to be mounted virtually anywhere. This plug-and-play modem ensures robust service even in challenging environments.

Robust Build Quality

The industrial-grade casing provides reliable high-speed connectivity in extreme conditions. The corrosion resistant zinc-plated steel case with wide operating temperature range and humidity tolerance mean that the DWM-314-G is ready for the most demanding M2M applications in virtually any environment.

Connection Diagram

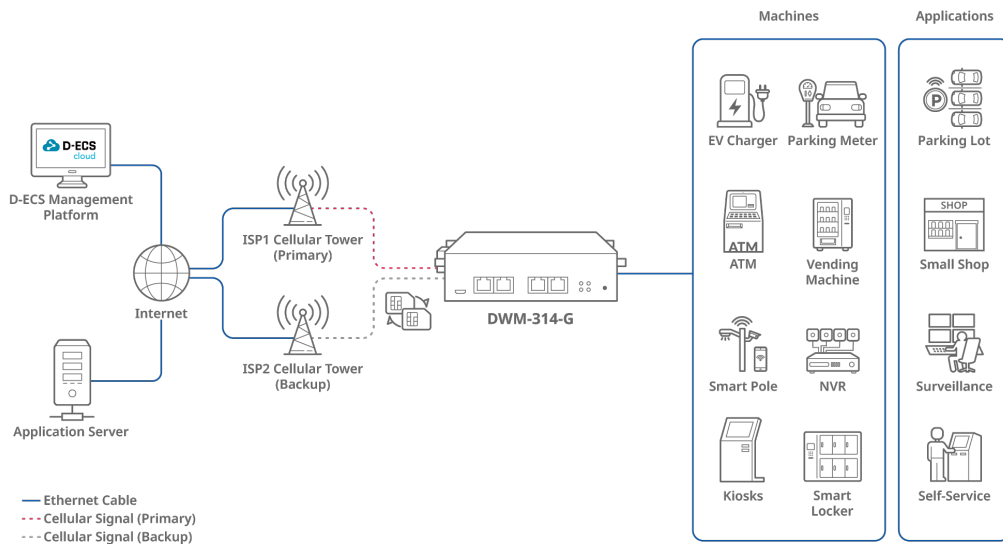

Specifications

Device Interface

- Cellular: 3GPP Rel. 16, 5G (sub-6 GHz), 4G (DL Cat 19/UL Cat 18)
- SIM Slot: 2 x SIM (Micro SIM) with auto failover, optional eSIM
- Ethernet: 4 x GE LAN ports
- Power Input: DC 9-36 V terminal block
- Antenna Connectors: 4 x SMA (F) cellular

Performance¹

- Maximum Cellular Data Throughput:
 - 5G NSA: 3.4 Gbps (DL) / 550 Mbps (UL)
 - 5G SA: 2.4 Gbps (DL) / 900 Mbps (UL)
 - LTE: 1.6 Gbps (DL) / 200 Mbps (UL)

WAN

- WAN Interface: Cellular
- Cellular: NAT
- Connection Monitoring: Ping query reboot

Network

- LAN: DHCP server
- Routing: Static
- DDNS: DynDNS, No-IP, dynamic DO

Services

- Event Management: SMS

VPN

- VPN Tunnel: OpenVPN, WireGuard

Security

- Firewall: IPS, port forward
- Access Control: MAC/IP filter

Administration

- Management: D-Link D-ECS²
- Maintenance: Web UI
- System: FW upgrade, reboot and reset

Monitoring

- Device Status: Connection information
- Cellular Status: Cellular information/status, cellular signal quality
- Security: VPN status

Operating Environment

- Operating Temperature: -30 to 70°C (-22°F to 158°F)
- Storage Temperature: -40 to 85°C (-40°F to 185°F)
- Operating Humidity: 10% to 95% non-condensing
- Storage Humidity: 0 to 95% non-condensing
- Dimensions: 149 x 99 x 40 mm

Certifications and Approvals

- Certifications: CE, UKCA
- Cyber Security: EN 18031-1, EN 18031-2, EN 303645

Package Contents (Standard)

- 4 x Cellular SMA Antennas
- 1 x RJ-45 Cable
- 1 x Power Adapter
- 1 x Terminal Block (2-pin)
- 1 x DIN-Rail Kit

Actual performances may vary due to settings, cabling, temperature, network configuration, interface, device compatibility, environmental and on-site conditions, and other similar factors. References to power capability, signal or processing speed, signal range or distance, data encryption, storage capacity, display properties, or other performance metrics are based on optimal conditions derived from industry standards and provided for informational purposes only. Specifications may be subject to change without prior notice.

Available Versions

EU SKU (HW: A1)

5G NR	n1/n3/n5/n7/n8/n20/n28/n38/n40/n41/n71/n75/n76/n77/n78
4G LTE	FDD: B1/B3/B5/B7/B8/B20/B28/B32/B71
	TDD: B38/B40/B41/B42/B43

Global SKU (HW: A2)

5G NR	n1/n2/n3/n5/n7/n8/n12/n13/n14/n18/n20/n25/n26/n28/n29/n30/n38/n40/n41/n48/n66/n70/n71/n75/n76/n77/n78/n79
4G LTE	FDD: B1/B2/B3/B4/B5/B7/B8/B12/B13/B14/B17/B18/B19/B20/B25/B26/B28/B29/B30/B32/B66/B71
	TDD: B34/B38/B39/B40/B41/B42/B43/B46(LAA)/B48

1 Data rates are theoretical. Data transfer rate depends on network capacity and signal strength.
 2 You only have to pay a M2M device license fee when applying for D-ECS license.

Hardware

Front View

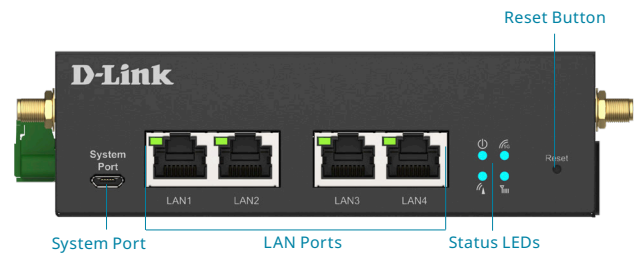

Side Views

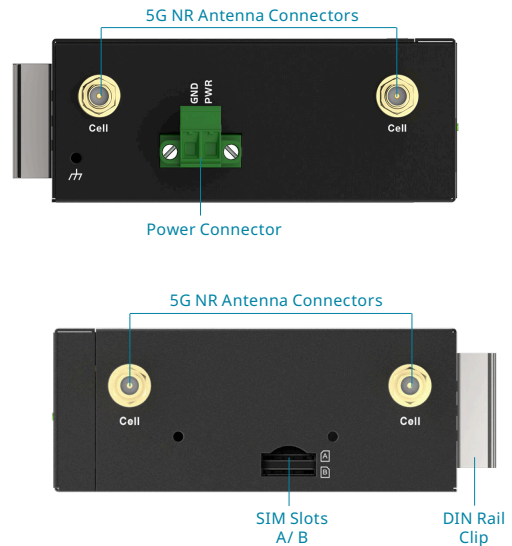

Spatial Measurement

The following diagrams provide the product's physical dimensions measured from top, front, left, and right views for installation and integration reference.

Unit: mm

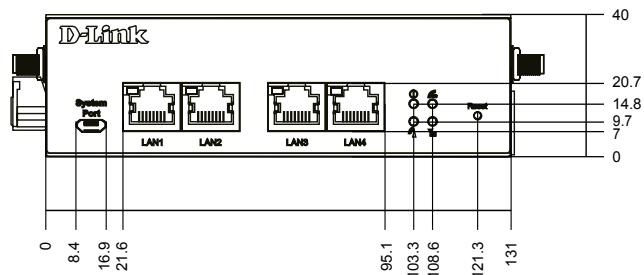
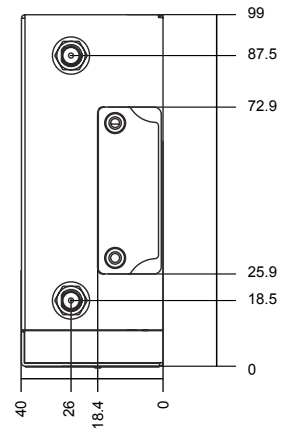
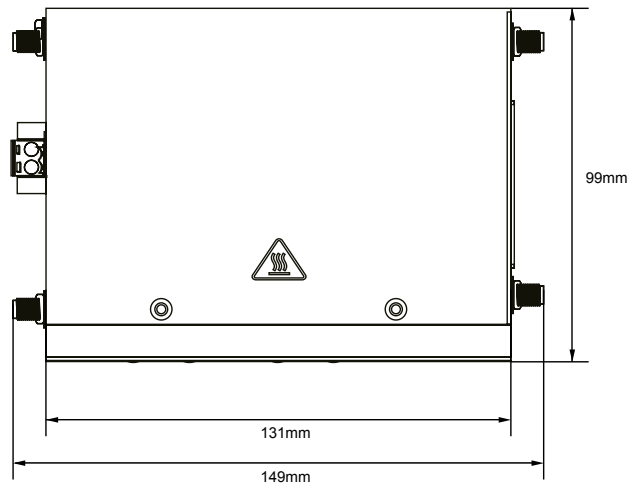
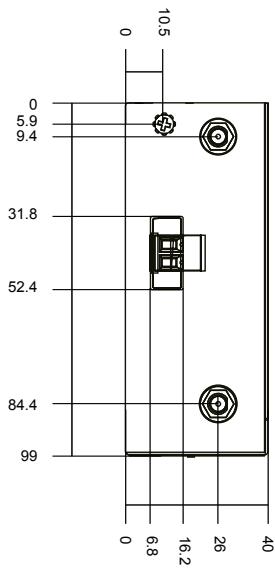

Mounting Space Requirements

